

川崎市型汚水ます3号

道路・側溝用コンクリート製品

下水道用コンクリート製品

ます類

その他取扱い製品

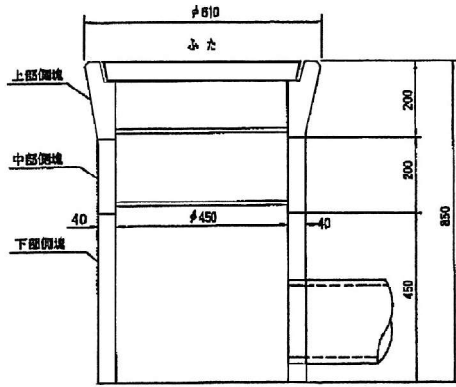

上部側塊 (T-6)

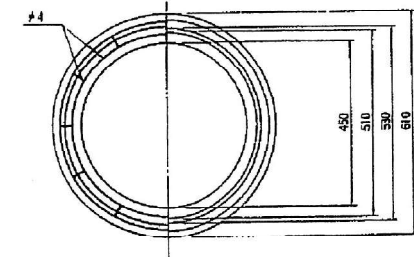

汚水マーク

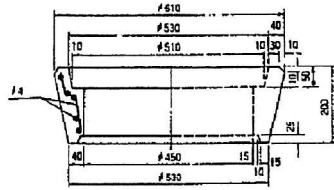
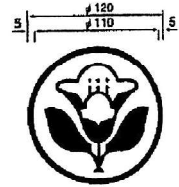

呼び名	参考重量(kg)
ふた	25
上部側塊	40
中部側塊	30
下部側塊	64

ふた

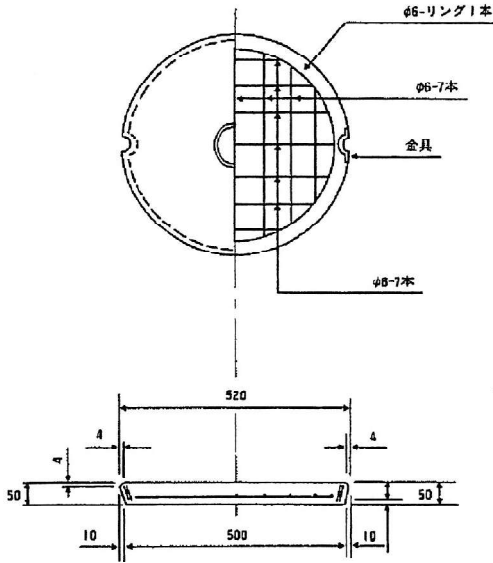

中部側塊

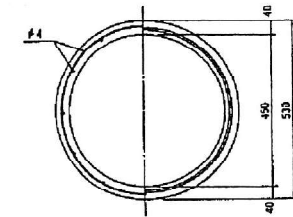

下部側塊

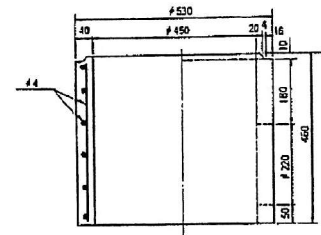
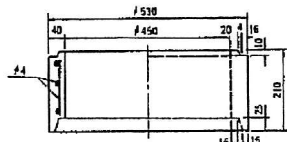
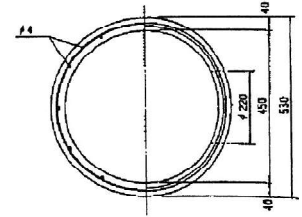

上部側塊 (T-14)

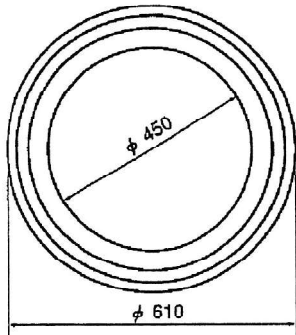

重量28 kg

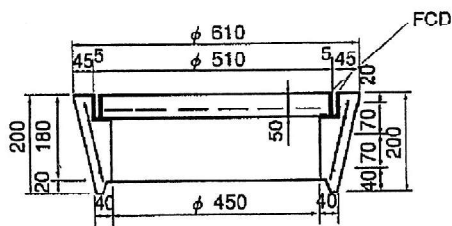

重量45 kg