

500用(受注製造)

躯体/重量(H=1000)684kg

縁塊/重量:65kg

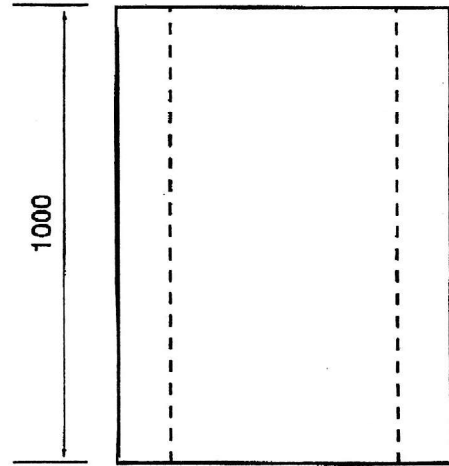
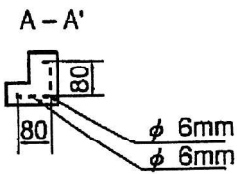
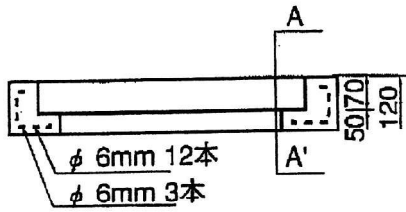
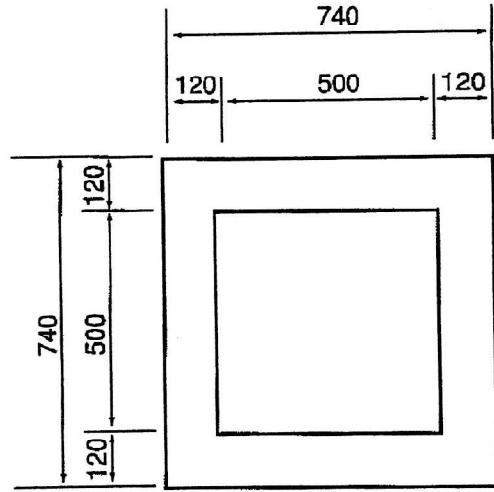
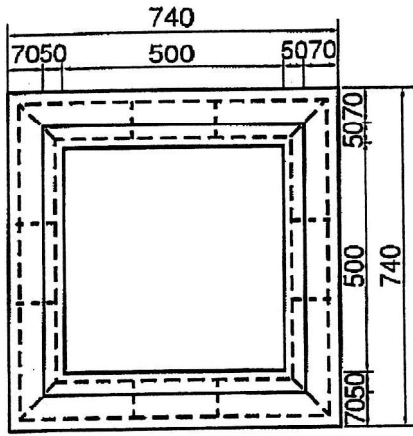

※高さ最大寸法は1000mmです。
切り欠き、高さは注文に応じます。

グレーチングふた(500用普通目)

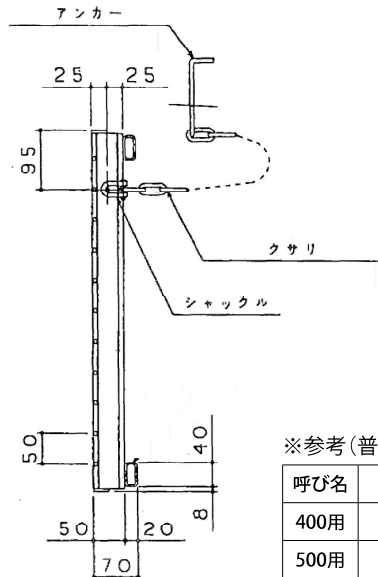
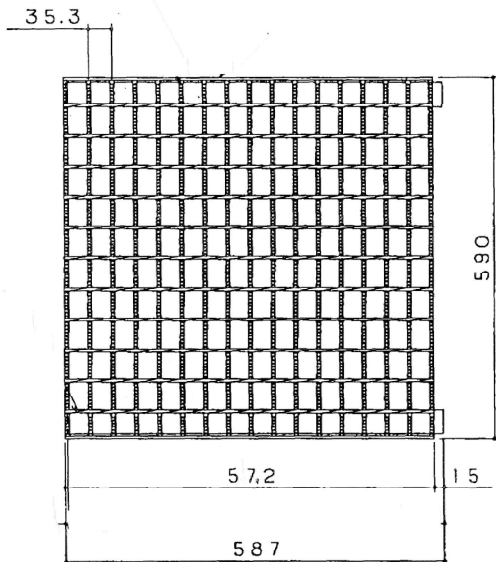

※参考(普通目)

呼び名	寸法	重量(kg)
400用	490×490×70/50	21.1
500用	590×590×70/50	25.5